



直得科技股份有限公司
CHIEFTEK PRECISION CO., LTD.

CLS Series



Compact Linear motor Stage

• cpc RESERVES THE RIGHT TO REVISE ANY INFORMATION AT ANY TIME WITHOUT NOTICE.

cpc CHIEFTEK PRECISION CO., LTD.

HEADQUARTERS
CHIEFTEK PRECISION CO., LTD.
No.3, Daji^{1st} Rd., Sinsih^{1st} Township,
Tainan Science Park, 741-45 Tainan, R.O.C
TEL: +886-6-505 5858 Http://www.chieftek.com
E-mail: service@mail.chieftek.com

CHIEFTEK PRECISION USA
4881 Murietta Street,
Chino, CA, 91710
Tel: +1-909-628-9300
Fax: +1-909-628-7171

cpc Europa GmbH
Industriepark 314,
D-78244 Gottmadingen, Germany
TEL: +49-7731-59130-38
FAX: +49-7731-59130-28

CHIEFTEK MACHINERY KUNSHAN CO., LTD.
No.1188, Hongqiao Rd, Kunshan,
Jiangsu, P.R. China
TEL: +86-512-5525 2831
FAX: +86-512-5525 2851



CLS-01-NB1-EN

Patent pending

CLS-01-NB1-EN

Contents

Introduction..... Page 01~02

Features of the Compact Linear motor Stage **CLS**

Linear motor Stage specification table..... Page 03~14

CLS-PM Module Parameters	CLS-PAX Module Parameters
CLS-PM Dynamic Characteristics	CLS-PAX Dynamic Characteristics
CLS-PM Assembly Dimensions	CLS-PAX Assembly Dimensions
CLS-PM Base Dimensions	CLS-PAX Base Dimensions
CLS-PM Wiring Definition	CLS-PAX Wiring Definition
CLS-PM Slider Dimension	CLS-PAX Slider Dimension
CLS-PM Mounting Dimension	CLS-PAX Mounting Dimension
CLS-PM Usage Suggestion	CLS-PAX Usage Suggestion

CLS-PBX Module Parameters
CLS-PBX Dynamic Characteristics
CLS-PBX Assembly Dimensions
CLS-PBX Base Dimensions
CLS-PBX Wiring Definition
CLS-PBX Slider Dimension
CLS-PBX Mounting Dimension
CLS-PBX Usage Suggestion

Ordering Information..... Page 15

Selection Application Table..... Page 16~21

CLS is a series of structurally compact linear motor modules. It tightly integrates a ironless linear motor, linear guide, optical scale and base. With its zero cogging force, high acceleration, high precision and smooth motion. It is high suitable for in applications such as AOI equipment, laser cutters, pick-place and scanning.

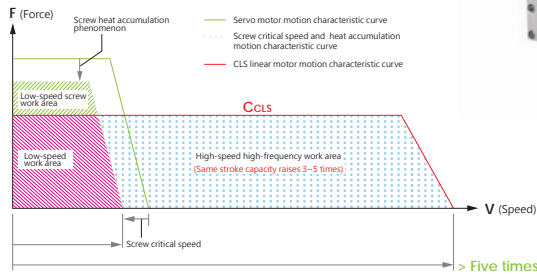

Compared to traditional ball screw modules, CLS series with direct drive coupling provides superior precision and velocity under many thrust output conditions. At the same time providing the same highly integrated mechanical design. Enabling increased productivity and reliability as a direct replacement.

Features

1 High rigidity · Compact structure

CLS combines the base, Linear motor, wide type linear guide supporting an aluminum slider and optical scale for position feedback. The entire module achieves high integration and rigidity, providing the user with an optimal choice under a given thrust requirement.

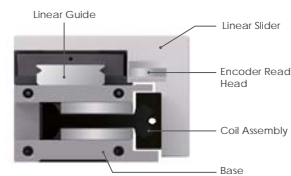

2 Lightweight · High velocity and acceleration

The linear motor in CLS is of the ironless type, combined with an aluminum slider it presents a low self load. This forms a combination suitable for high acceleration and high velocity motion.

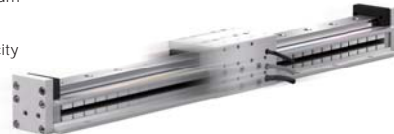

3 Smooth motion

CLS uses ironless linear motor as the actuator with no cogging force, achieving high stability under low and high velocity motion.

4 High precision

High precision positioning fully closed loop control with optical encoder based feedback. Optional precision grades of Normal (N), High (H) or custom (P) for even higher precision.

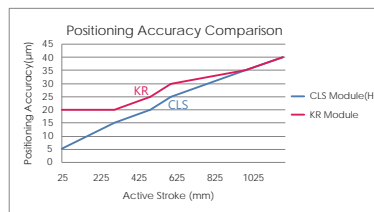

Customers can customize for higher accuracy P class CLS Module.

5 Multiple slider on same axis

CLS can contains multiple sliders on the same axis, each individually controllable.



6 Easy maintenance, long period between lubricant refill

CLS uses linear motor and slider with built-in lubrication pad, increasing lubrication life and reapplication period.

Environmentally friendly lubrication design Z series-end seal and lubrication pad

The two ends of the runner blocks are respectively provided with a hermetically sealed lubrication grease injection design, capable of bringing the lubrication grease to the raceway by means of steel ball circulation, thereby achieving a lubrication effect. A built-in lubrication pad is optionally provided upon the design, further preserving the lubrication effect during long-term running, thereby reducing the maintenance cost, and further provides enhanced lubrication capability during short stroke running.

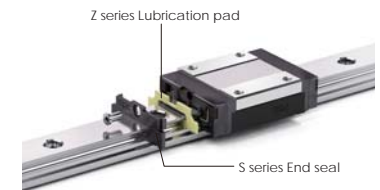

7 High speed linear guide design

WRC-Series- Ball Type Linear Guide wide Model

CLS-PBX Series-This module equipped with WRC-linear guide, the block uses stainless steel reinforcement plate to enhance rigidity which can $V_{max}=10m/s$ · $a_{max}=450m/sec^2$

MR-W Series-Miniature Linear Guide

CLS-PM & CLS-PAX Series -This module equipped with miniature linear guide, which can endure $V_{max}=3m/s$ · $a_{max}=250m/sec^2$
Under high speed application, (customized code: /V), the block equipped with stainless steel reinforcement plate, the capability increasing to $V_{max}=9m/s$ · $a_{max}=300m/sec^2$



8 Customization

CLS modules can be customized for specific customer applications. Options include: Mounting hole position, cable exit method, linear guide model, weight reduction, specific travel range etc.





CLS - PM series

CLS-PM Module Parameters

CLS	PM-4	PM-6				
Motor parameters						
Continuous Force (N)	18.5	25.5				
Peak Force (N)	74	102.5				
Continuous Current (Apeak)	5	4.6				
Peak Current (Apeak)	20	18.4				
Force Constant (N/Apeak)	3.7	5.5				
Back EMF constant (VL-L/m/s)	4.3	6.5				
Resistance (Ohms)	1.2	1.7				
Inductance (mH)	0.04	0.07				
Magnetic Pole Pitch (mm)	15	15				
Stage parameters						
Total Length (mm)	152	332	512	152	332	512
Effective Travel (mm)	45	225	405	15	195	375
Slider Mass (kg) ⁽¹⁾	0.25		0.35		0.35	
Module Weight(kg) ⁽¹⁾	0.7	1.4	2.1	0.9	1.5	2.2
Accuracy ⁽²⁾						
Straightness/Flatness(μm)	6	8	10	6	8	10
Repeatability(μm) ⁽³⁾	±1	±1	±1	±1	±1	±1
Linear Guide Rated Load and Static Moment						
Model Code	MR7WN	MR7WL				
Block quantity	2	2				
Load Capacity (KN)	C (dyn)	2.4	3.1			
	Co (stat)	4.2	6.3			
Static Moment (Nm)	Mro(Nm)	30	45.3			
	Mpo(Nm)	40.7	97.2			
	Myo(Nm)	40.7	97.2			

(1) Moving Load refers to mass before addition of payload mass. This includes the slider platform, motor forcer, linear guide, cabling, optical encoder read head etc. For the Connector type termination option it is 0.12kg.

(2) All listed precision figures are for the High Precision grade (H grade). There are no precision measurement specifications for the Normal grade.

(3) System repeatability can be increased with the selection 0.5μm or 0.1μm grade optical encoders.



Dynamic Characteristics

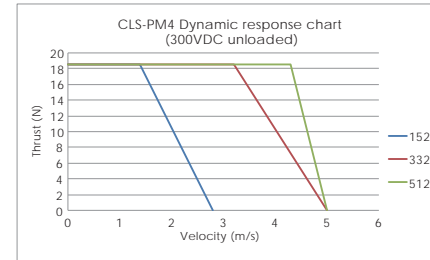

The chart is made with maximum velocity set to 5m/s, for higher velocity or special requirements, contact **cpc**

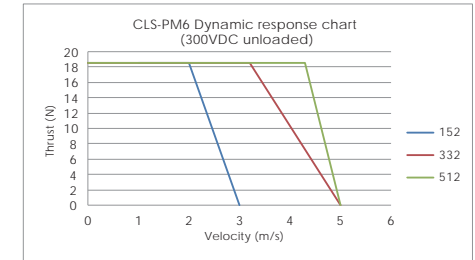

The chart is made with maximum velocity set to 5m/s, for higher velocity or special requirements, contact **cpc**

Assembly Dimensions

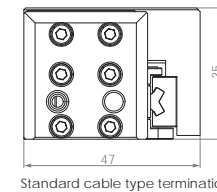

Standard cable type termination

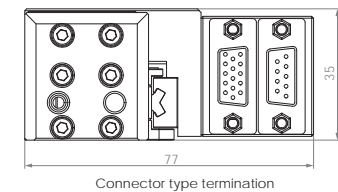

Connector type termination

Wiring Definition

Standard cable type termination

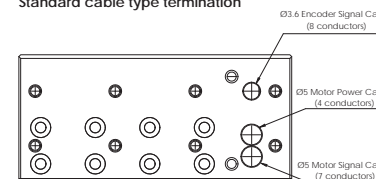

OUTPUT CABLE

Motor Wire Table		Hall Sensor Wire Table and Thermal Protection Wire Table				Encoder Signal connections	
Color	Function	Color	Function	Color	Function	Color	Function
White	phase U	Pink	Hall A U phase	Brown/Bus	Thermal sensor	Black	GND
Yellow	phase V	Yellow	Hall B V phase			Brown	Index-
Brown	phase W	Green	Hall C W phase			Blue	B+
Green	PE	Grey	Hall IC + 5V			Yellow	A-
		White	GND			Red	5V
						Orange	Index+
						Purple	B+
						Green	A+

Connector type termination

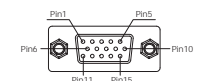
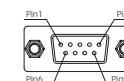
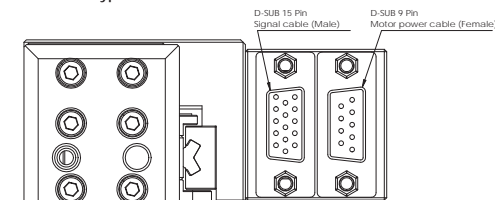

Pin No.	Function
1	
2	U
6	
7	V
8	
4	B+
5	W
9	Hall A U phase
Frame	Isolation & GND

Pin No.	Function
1	GND
2	Index-
3	B-
4	A-
5	5V
6	Index+
7	B+
8	A+
9	Hall A U phase
10	Hall B V phase

Pin No.	Function
11	Hall C W phase
12	Hall IC + 5V
13	Hall GND
14	Thermal sensor
15	Thermal sensor
Frame	Isolation

Slider Dimension

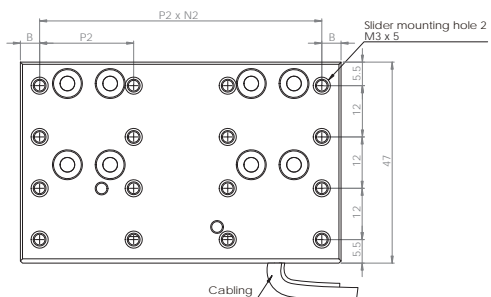
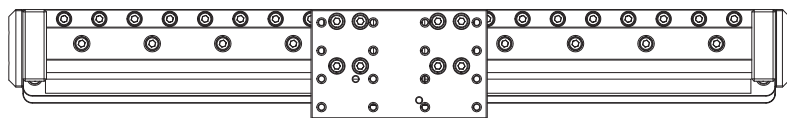
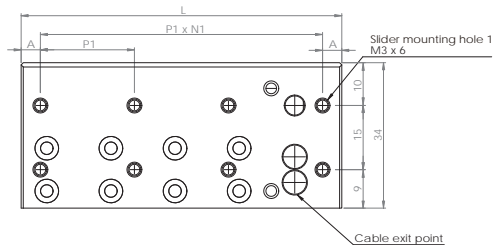
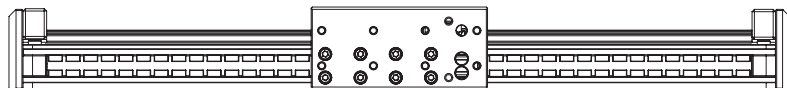

Motor Model	Slider Length (L)	A	P1	N1	B	P2	N2
PM4	75	4.5	22	3	4.5	22	3
PM6	105	7.5	30	3	7.5	30	3

Unit: mm

Mounting Dimension

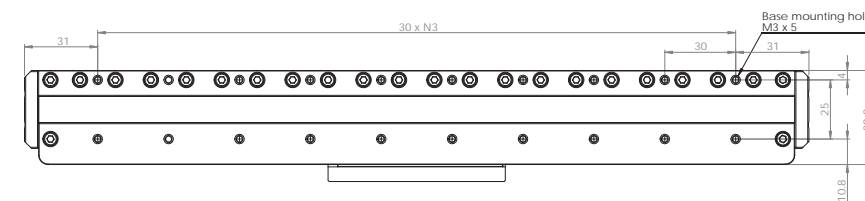
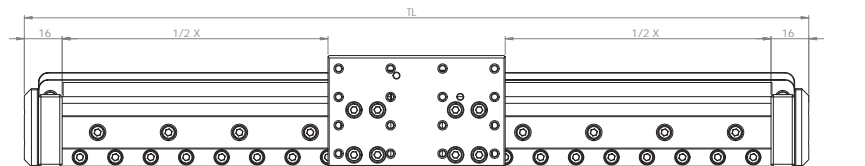

Motor Model	Total Length (TL)	Effective Travel (X)	Unit: mm
			N3
PM4	152	45	3
	332	225	9
	512	405	15
PM6	152	15	3
	332	195	9
	512	375	15

Usage Suggestion

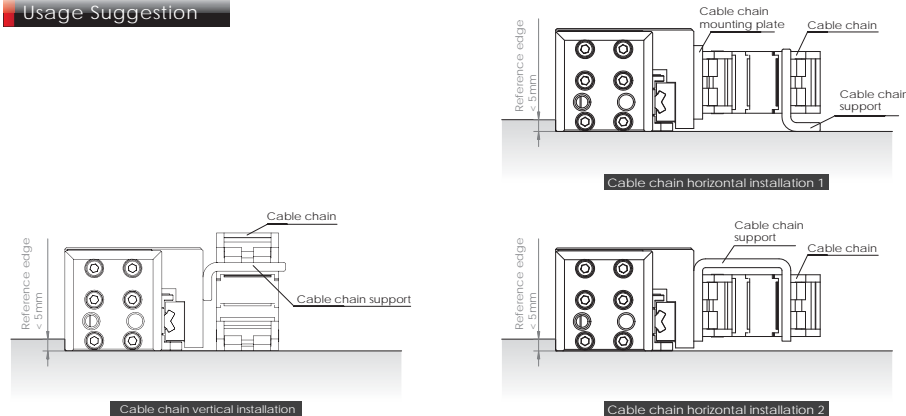



CLS - PAX series

CLS-PAX Module Parameters

CLS	PA-X2						PA-X4						
Motor parameters													
Continuous Force (N)	31						55						
Peak Force (N)	123.8						220.2						
Continuous Current (A _{peak})	3.6						3.2						
Peak Current (A _{peak})	14.4						12.8						
Force Constant (N/A _{peak})	8.6						17.2						
Back EMF constant (VL/m/s)	10						20						
Resistance (Ohms)	4.3						8.5						
Inductance (mH)	0.83						1.65						
Magnetic Pole Pitch (mm)	30						30						
Stage parameters													
Total Length (mm)	220	340	520	820	1000	1480	220	340	520	820	1000	1480	
Effective Travel (mm)	90	210	390	690	870	1350	30	150	330	630	810	1290	
Slider Mass (kg) ⁽¹⁾	0.5						0.8						
Module Weight(kg) ⁽¹⁾	2.1	2.9	3.9	5.7	7.5	16.2	2.4	3.2	4.2	6	7.8	16.5	
Accuracy⁽²⁾													
Straightness/Flatness(μm)	6	8	10	20	20	25	6	8	10	20	20	25	
Repeatability(μm) ⁽³⁾	±1	±1	±1	±2	±2	±2	±1	±1	±1	±2	±2	±2	
Linear Guide Rated Load and Static Moment													
Model Code	MR12WN						MR12WL						
Block quantity	2						2						
Load Capacity (KN)	C (dyn)	6.1						8.1					
	Co (stat)	10.4						15.6					
Static Moment (Nm)	Mro(Nm)	127						191					
	Mpo(Nm)	124						341					
	Myo(Nm)	124						341					

(1) Moving Load refers to mass before addition of payload mass. This includes the slider platform, motor forcer, linear guide, cabling, optical encoder read head etc. For the Connector type termination option it is 0.12kg.

(2) All listed precision figures are for the High Precision grade (H grade). There are no precision measurement specifications for the Normal grade.

(3) System repeatability can be increased with the selection 0.5μm or 0.1μm grade optical encoders.



Dynamic Characteristics

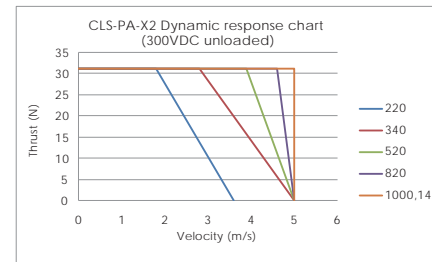

The chart is made with maximum velocity set to 5m/s, for higher velocity or special requirements, contact **cpc**

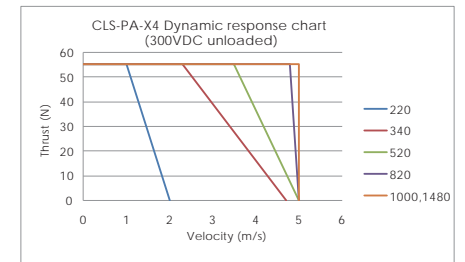

The chart is made with maximum velocity set to 5m/s, for higher velocity or special requirements, contact **cpc**

Assembly Dimensions

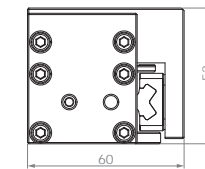

Standard cable type termination

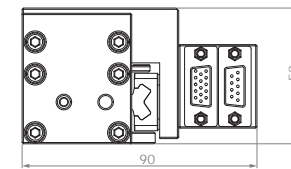

Connector type termination

Wiring Definition

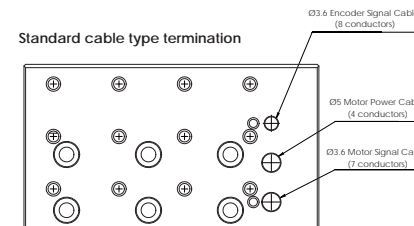

Standard cable type termination

Motor Wire Table		Hall Sensor Wire Table and Thermal Protection Wire Table	
Color	Function	Color	Function
White	phase U	Pink	Hall A U phase
Yellow	phase V	Yellow	Hall B V phase
Brown	phase W	Green	Hall C W phase
Green	PE	Grey	Hall IC + 5V
		White	GND

OUTPUT CABLE

Encoder Signal connections	
Color	Function
Black	GND
Blue	Index-
Brown	B-
Yellow	A-
Red	5V
Orange	Index+
Purple	B+
Green	A+

Connector type termination

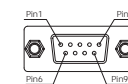
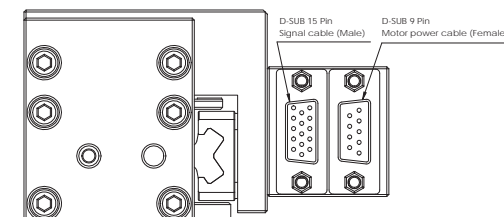

Pin No.	Function
1	
2	U
6	
3	
7	V
8	
4	
5	W
9	
Frame	Isolation & GND

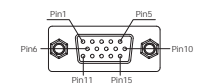

Pin No.	Function
1	GND
2	Index-
3	B-
4	A-
5	5V
6	Index+
7	B+
8	A+
9	Hall A U phase
10	Hall B V phase

Slider Dimension

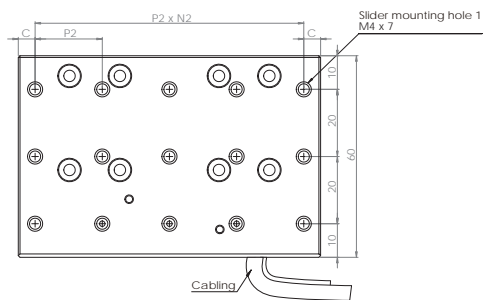
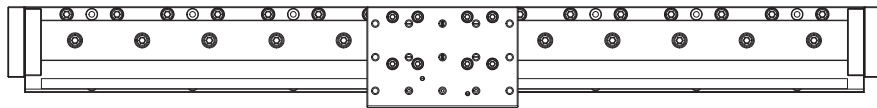
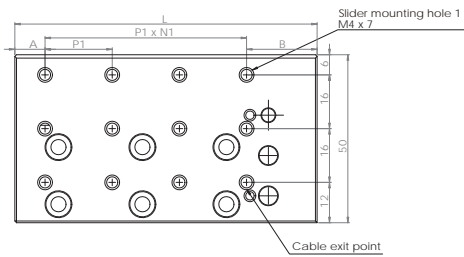
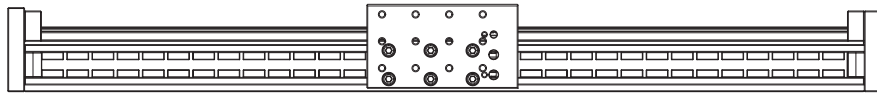

Motor Model	Slider Length (L)	A	B	P1	N1	C	P2	N2
PA-X2	90	9	21	20	3	15	20	3
PA-X4	150	5	5	35	4	5	35	4

Unit: mm

Mounting Dimension

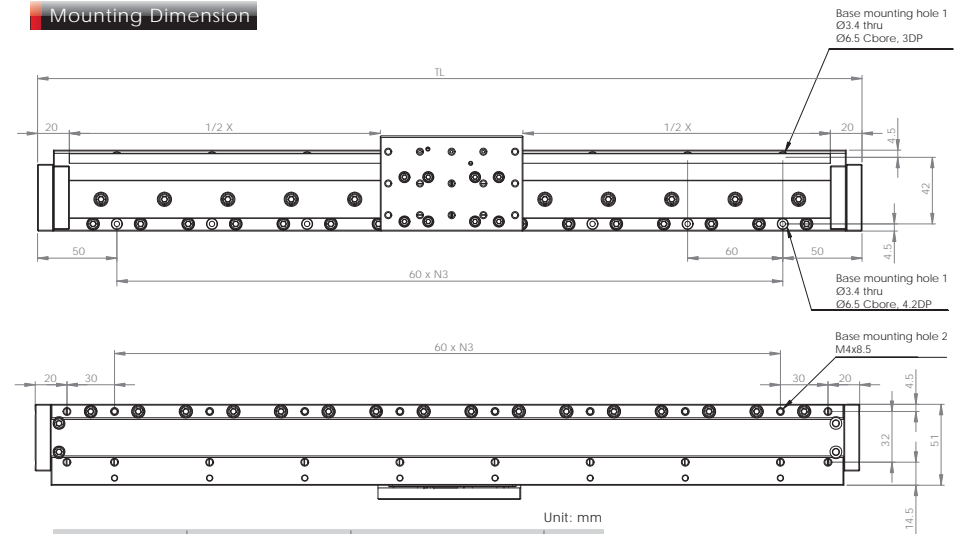

Motor Model	Unit: mm		
	Total Length (TL)	Effective Travel (X)	N3
PA-X2	220	90	2
	340	210	4
	520	390	7
	820	690	12
	1000	870	15
PA-X4	1480	1350	23
	220	30	2
	340	150	4
	520	330	7
	820	630	12
	1000	810	15
	1480	1290	23

Usage Suggestion

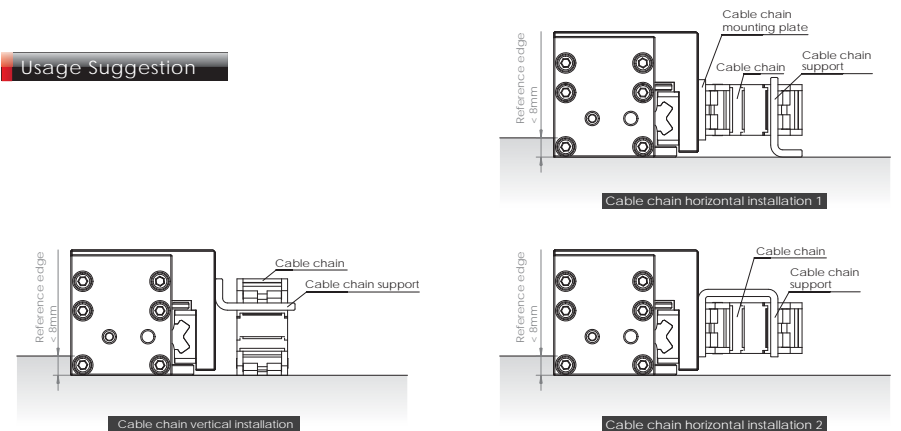



CLS - PBX series

CLS-PBX Module Parameters

CLS	PB-X2						PB-X4						PB-X6						
Motor parameters																			
Continuous Force (N)	56.8						107.8						153.3						
Peak Force (N)	227						431.4						613						
Continuous Current (Apeak)	4						3.8						3.6						
Peak Current (Apeak)	16						15.2						14.4						
Force Constant (N/Apeak)	14.2						28.4						42.6						
Back EMF constant (VL/m/s)	16.5						33						49.5						
Resistance (Ohms)	4.1						8.3						12.4						
Inductance (mH)	1.44						2.87						4.31						
Magnetic Pole Pitch (mm)	30						30						30						
Stage parameters																			
Total Length (mm)	230	530	830	1010	1250	1490	230	530	830	1010	1250	1490	530	830	1010	1250	1490		
Effective Travel (mm)	95	395	695	875	1115	1355	35	335	635	815	1055	1295	275	575	755	995	1235		
Slider Mass (kg) ⁽¹⁾	0.7						1						1.3						
Module Weight(kg) ⁽¹⁾	3.7	8.5	13.3	16.2	20	23.9	4	8.8	13.6	16.5	20.3	24.2	9.4	14.2	17.1	20.9	24.8		
Accuracy⁽²⁾																			
Straightness/Flatness(μm)	6	10	20	20	25	30	6	10	20	20	25	30	10	20	20	25	30		
Repeatability(μm) ⁽³⁾	±1	±1	±2	±2	±2	±2	±1	±1	±1	±1	±2	±2	±1	±1	±2	±2	±2		
Linear Guide Rated Load and Static Moment																			
Model Code	WRC21/15MN						WRC21/15MN						WRC21/15MN						
Block quantity	1						2						2						
Load Capacity (KN)	C (dyn)	9.9						19.8						19.8					
	Co (stat)	17.5						35.5						35.5					
Static Moment (Nm)	Mro(Nm)	315						630						630					
	Mpo(Nm)	105						670						1078					
	Myo(Nm)	105						670						1078					

(1) Moving Load refers to mass before addition of payload mass. This includes the slider platform, motor forcer, linear guide, cabling, optical encoder read head etc. For the Connector type termination option it is 0.12kg.

(2) All listed precision figures are for the High Precision grade (H grade). There are no precision measurement specifications for the Normal grade.

(3) System repeatability can be increased with the selection 0.5μm or 0.1μm grade optical encoders.



Dynamic Characteristics

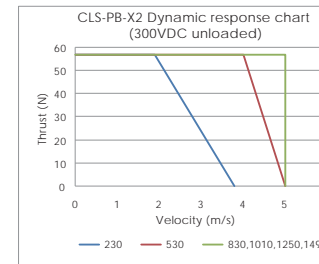

The chart is made with maximum velocity set to 5m/s, for higher velocity or special requirements, contact **cpc**

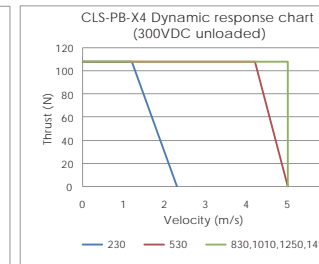

The chart is made with maximum velocity set to 5m/s, for higher velocity or special requirements, contact **cpc**

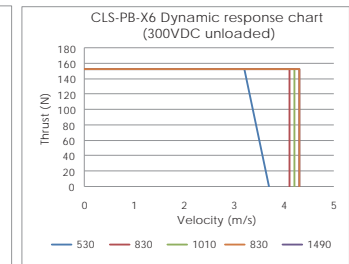

The chart is made with maximum velocity set to 5m/s, for higher velocity or special requirements, contact **cpc**

Assembly Dimensions

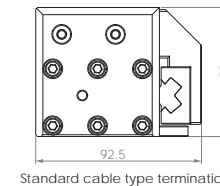

Standard cable type termination

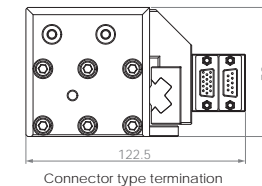

Connector type termination

Wiring Definition

Standard cable type termination

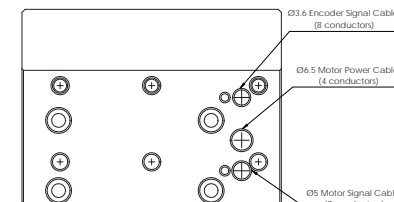

OUTPUT CABLE

Motor Wire Table		Hall Sensor Wire Table and Thermal Protection Wire Table	
Color	Function	Color	Function
White	phase U	Pink	Hall A U phase
Yellow	phase V	Yellow	Hall B V phase
Brown	phase W	Green	Hall C W phase
Green	PE	Grey	Hall IC + 5V
		White	GND

Encoder Signal connections

Color	Function
Black	GND
Brown	Index-
Blue	B-
Yellow	A-
Red	5V
Orange	Index+
Purple	B+
Green	A+

Connector type termination

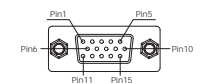
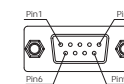
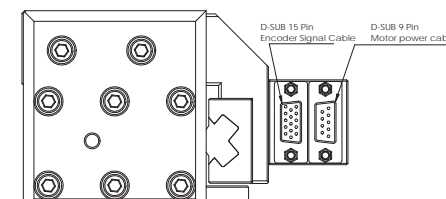

Pin No.	Function
1	
2	U
6	
7	
8	V
9	W
10	
11	
12	
13	
14	
15	

Pin No.	Function
1	GND
2	Index-
3	B-
4	A-
5	5V
6	Index+
7	B+
8	A+
9	Hall A U phase
10	Hall B V phase

Pin No.	Function
11	Hall C W phase
12	Hall IC + 5V
13	Hall GND
14	Thermal sensor
15	Thermal sensor
	Frame Isolation

Slider Dimension

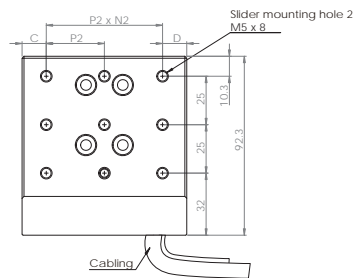
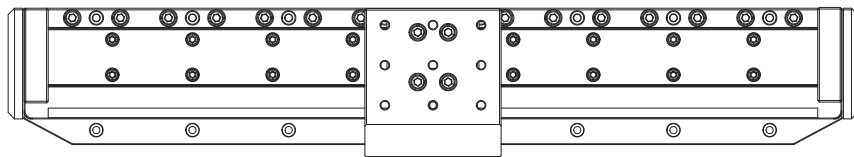
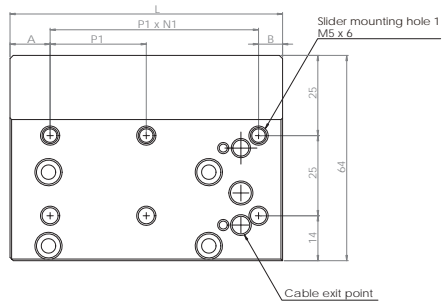
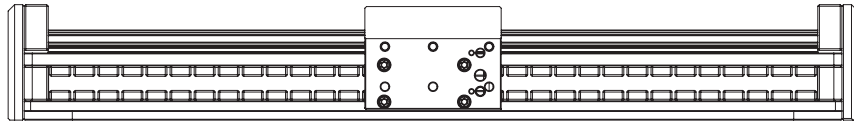

Motor Model	Slider Length (L)	A	B	P1	N1	C	D	P2	N2
PB-X2	85	12.5	7.5	30	2	12.5	7.5	30	3
PB-X4	145	5	5	45	3	12.5	12.5	40	3
PB-X6	205	13	32	40	4	13	32	40	4

Mounting Dimension

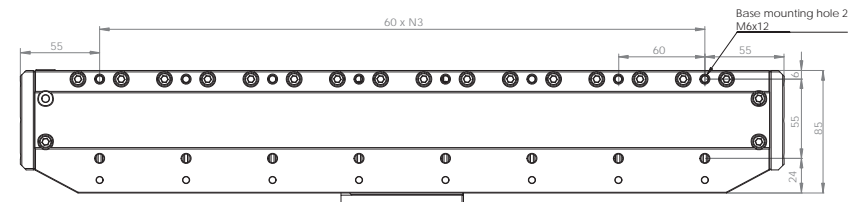
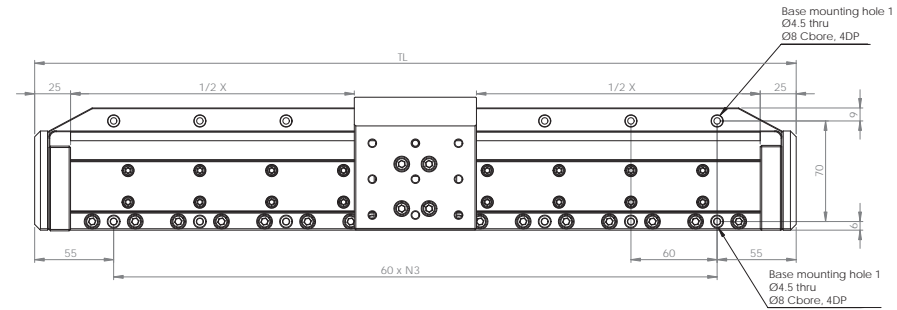

Motor Model	Unit: mm		
	Total Length (TL)	Effective Travel (X)	N3
PB-X2	230	95	2
	530	395	7
	830	695	12
	1010	875	15
	1250	1115	19
PB-X4	1490	1355	23
	230	35	3
	530	335	7
	830	635	12
	1010	815	15
PB-X6	1250	1055	19
	1490	1295	23

Motor Model	Unit: mm		
	Total Length (TL)	Effective Travel (X)	N3
PB-X6	530	275	7
	830	575	12
	1010	755	15
	1250	995	19
	1490	1235	23

Usage Suggestion

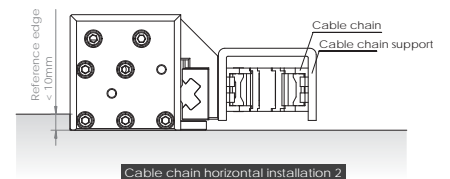
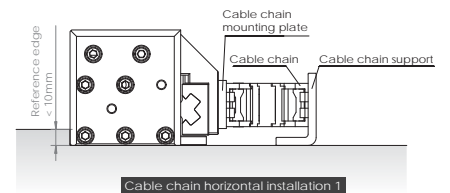
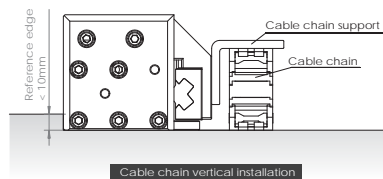

Ordering information

CLS	512	PM	4	395	CA	_	A	II	3	/J
										Customization code
										Exit Cable Length: 1,2,3,4,5,6,7,8,9(m)
										Number of Sliders
										Resolution: A : 1μm B : 0.5μm C : 0.1μm
										Slider Type: Standard CR: Dust Seal
										Cable interface: CA cable CN: Connector
Effective Travel: PM4 : 45,225,405mm PM6 : 15,195,375mm PAX2 : 90,210,390,690,870,1350mm PAX4 : 30,150,330,630,810,1290mm PBX2 : 95,395,695,875,1115,1355mm PBX4 : 35,335,635,815,1055,1295mm PBX6 : 275,575,755,995,1235mm										
Number of coil assembly : PM : 4,6 PAX : 2,4 PBX : 2,4,6										
Motor Model : PM,PAX,PBX										
Total Length : PM4 : 152,332,512mm PBX2 : 230,530,830,1010,1250,1490mm PM6 : 152,332,512mm PBX4 : 230,530,830,1010,1250,1490mm PAX2 : 220,340,520,820,1000,1480mm PBX6 : 530,830,1010,1250,1490mm PAX4 : 220,340,520,820,1000,1480mm										
Compact Linear Motor Module										

Customized needs (The meaning of the suffix letter Description)

G : Customer designate lubricant V : High speed requested : 3m/s < V < 9m/s or a_{max} = 300m/sec² (PM, PAX)
J : Other Customization

Accessory Options

CLS	AC	5	230	CN
Compact Linear Motor Module	220V AC Driver	Rated Current: 5A	Input Voltage 230V	Blank: None CN: Connector

Sizing Form

Customer Name /	Filling Date(DD/MM/YEAR) /
Contact Person /	Telephone /
E-mail /	Fax /

1. Point-to-Point Motion without constant velocity section

Property: Specific travel distance in specific time

Application: Pick and place, carriage etc.

a. Known Motion Condition	
(1) Load Mass	kg
(2) Effective Stroke	m
(3) Moving Time	s
(4) Dwell Time	s

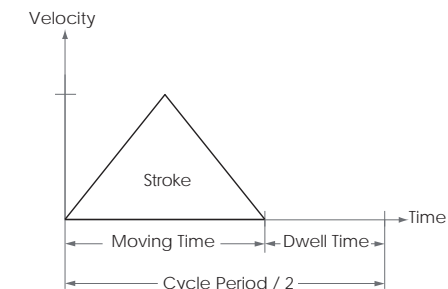

b. Driver Condition	
(1) Max. Output Voltage	V
(2) Continuous Current	A
(3) Peak Current	A

c. Encoder	
(1) <input type="checkbox"/> Analog <input type="checkbox"/> Digital	
(2) Resolution	μm

f. Motion Direction	
(1) <input type="checkbox"/> Horizontal	
(2) <input type="checkbox"/> Vertical	
(3) <input type="checkbox"/> Tilt _____ Degrees	

d. Working Environment	
(1) <input type="checkbox"/> Room Temperature	
(2) <input type="checkbox"/> Constant Temperature _____°C	
(3) <input type="checkbox"/> Vacuum _____ Torr	
(4) <input type="checkbox"/> Clean Room _____ Level	

g. Installation Method	
(1) <input type="checkbox"/> Lying Flat	
(2) <input type="checkbox"/> Vertically standing	
(3) <input type="checkbox"/> Wall Mount	

e. Motion Precision	
(1) Positioning Accuracy	μm
(2) Repetitive Accuracy	μm

h. Space Restrictions	
(1) <input type="checkbox"/> None	
(2) <input type="checkbox"/> Yes _____mm x _____mm x _____mm	

Sizing Form

Customer Name /	Filling Date(DD/MM/YEAR) /
Contact Person /	Telephone /
E-mail /	Fax /

2. Point-to-Point Motion without constant velocity section

Property: Specific travel distance in specific time
 Application: Pick and place, carriage etc.

a. Known Motion Condition	
(1) Load Mass	kg
(2) Effective Stroke	m
(3) Frequency	Hz
(4) Dwell Time	s

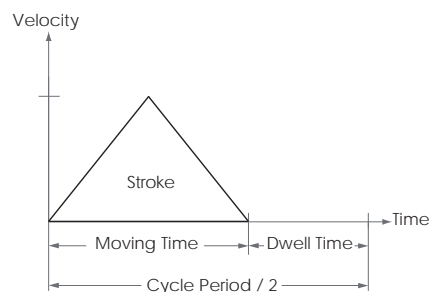

b. Driver Condition	
(1) Max. Output Voltage	V
(2) Continuous Current	A
(3) Peak Current	A

c. Encoder	
(1) <input type="checkbox"/> Analog <input type="checkbox"/> Digital	
(2) Resolution	μm

f. Motion Direction	
(1) <input type="checkbox"/> Horizontal	
(2) <input type="checkbox"/> Vertical	
(3) <input type="checkbox"/> Tilt _____ Degrees	

d. Working Environment	
(1) <input type="checkbox"/> Room Temperature	
(2) <input type="checkbox"/> Constant Temperature _____°C	
(3) <input type="checkbox"/> Vacuum _____ Torr	
(4) <input type="checkbox"/> Clean Room _____ Level	

g. Installation Method	
(1) <input type="checkbox"/> Lying Flat	
(2) <input type="checkbox"/> Vertically standing	
(3) <input type="checkbox"/> Wall Mount	

e. Motion Precision	
(1) Positioning Accuracy	μm
(2) Repetitive Accuracy	μm

h. Space Restrictions	
(1) <input type="checkbox"/> None	
(2) <input type="checkbox"/> Yes _____mm x _____mm x _____mm	

Sizing Form

Customer Name /	Filling Date(DD/MM/YEAR) /
Contact Person /	Telephone /
E-mail /	Fax /

3. Point-to-Point Motion without constant velocity section

Property: Specific travel distance in specific time
 Application: Pick and place, carriage etc.

a. Known Motion Condition	
(1) Load Mass	kg
(2) Effective Stroke	m
(3) Acceleration	m/s ²
(4) Dwell Time	s

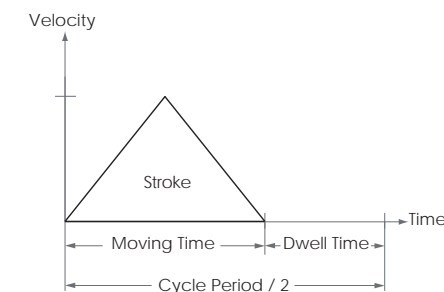

b. Driver Condition	
(1) Max. Output Voltage	V
(2) Continuous Current	A
(3) Peak Current	A

c. Encoder	
(1) <input type="checkbox"/> Analog <input type="checkbox"/> Digital	
(2) Resolution	μm

f. Motion Direction	
(1) <input type="checkbox"/> Horizontal	
(2) <input type="checkbox"/> Vertical	
(3) <input type="checkbox"/> Tilt _____ Degrees	

d. Working Environment	
(1) <input type="checkbox"/> Room Temperature	
(2) <input type="checkbox"/> Constant Temperature _____°C	
(3) <input type="checkbox"/> Vacuum _____ Torr	
(4) <input type="checkbox"/> Clean Room _____ Level	

g. Installation Method	
(1) <input type="checkbox"/> Lying Flat	
(2) <input type="checkbox"/> Vertically standing	
(3) <input type="checkbox"/> Wall Mount	

e. Motion Precision	
(1) Positioning Accuracy	μm
(2) Repetitive Accuracy	μm

h. Space Restrictions	
(1) <input type="checkbox"/> None	
(2) <input type="checkbox"/> Yes _____mm x _____mm x _____mm	

Sizing Form

Customer Name /	Filling Date(DD/MM/YEAR) /
Contact Person /	Telephone /
E-mail /	Fax /

4. Point-to-Point Motion with constant velocity section

Property: Work performed under constant velocity
 Application: Scanning, inspection, cutting etc.

a. Motion Condition	
(1) Load Mass	kg
(2) Effective Stroke	m
(3) Moving Time	s
(4) Dwell Time	s
(5) Acceleration	m/s ²

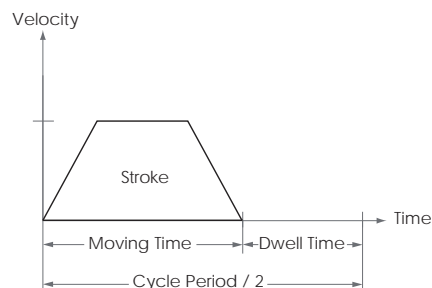

b. Driver Condition	
(1) Max. Output Voltage	V
(2) Continuous Current	A
(3) Peak Current	A

c. Encoder	
(1) <input type="checkbox"/> Analog <input type="checkbox"/> Digital	
(2) Resolution	μm

f. Motion Direction	
(1) <input type="checkbox"/> Horizontal	
(2) <input type="checkbox"/> Vertical	
(3) <input type="checkbox"/> Tilt _____ Degrees	

d. Working Environment	
(1) <input type="checkbox"/> Room Temperature	
(2) <input type="checkbox"/> Constant Temperature _____ °C	
(3) <input type="checkbox"/> Vacuum _____ Torr	
(4) <input type="checkbox"/> Clean Room _____ Level	

g. Installation Method	
(1) <input type="checkbox"/> Lying Flat	
(2) <input type="checkbox"/> Vertically standing	
(3) <input type="checkbox"/> Wall Mount	

e. Motion Precision	
(1) Positioning Accuracy	μm
(2) Repetitive Accuracy	μm

h. Space Restrictions	
(1) <input type="checkbox"/> None	
(2) <input type="checkbox"/> Yes _____ mm x _____ mm x _____ mm	

Sizing Form

Customer Name /	Filling Date(DD/MM/YEAR) /
Contact Person /	Telephone /
E-mail /	Fax /

5. Point-to-Point Motion with constant velocity section

Property: Work performed under constant velocity
 Application: Scanning, inspection, cutting etc.

a. Motion Condition	
(1) Load Mass	kg
(2) Effective Stroke	m
(3) Max. Velocity	m/s
(4) Acceleration Time	s
(5) Dwell Time	s

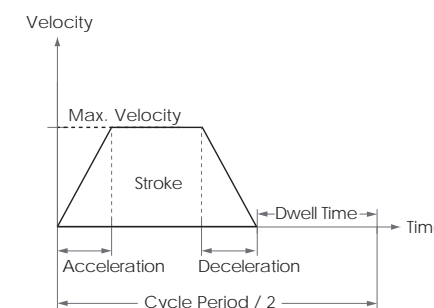

b. Driver Condition	
(1) Max. Output Voltage	V
(2) Continuous Current	A
(3) Peak Current	A

c. Encoder	
(1) <input type="checkbox"/> Analog <input type="checkbox"/> Digital	
(2) Resolution	μm

f. Motion Direction	
(1) <input type="checkbox"/> Horizontal	
(2) <input type="checkbox"/> Vertical	
(3) <input type="checkbox"/> Tilt _____ Degrees	

d. Working Environment	
(1) <input type="checkbox"/> Room Temperature	
(2) <input type="checkbox"/> Constant Temperature _____ °C	
(3) <input type="checkbox"/> Vacuum _____ Torr	
(4) <input type="checkbox"/> Clean Room _____ Level	

g. Installation Method	
(1) <input type="checkbox"/> Lying Flat	
(2) <input type="checkbox"/> Vertically standing	
(3) <input type="checkbox"/> Wall Mount	

e. Motion Precision	
(1) Positioning Accuracy	μm
(2) Repetitive Accuracy	μm

h. Space Restrictions	
(1) <input type="checkbox"/> None	
(2) <input type="checkbox"/> Yes _____ mm x _____ mm x _____ mm	

Sizing Form

Customer Name /	Filling Date (DD/MM/YEAR) /
Contact Person /	Telephone /
E-mail /	Fax /

6. Point-to-Point Motion with constant velocity section

Property: Work performed under constant velocity
 Application: Scanning, inspection, cutting etc.

a. Motion Condition	
(1) Load Mass	kg
(2) Effective Stroke	m
(3) Moving Time	s
(4) Acceleration	m/s ²
(5) Dwell Time	s

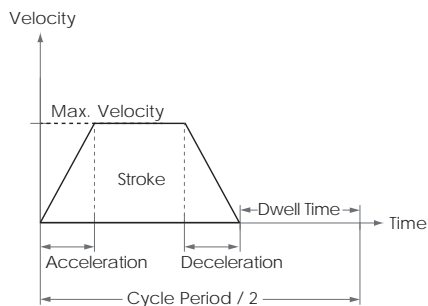

b. Driver Condition	
(1) Max. Output Voltage	V
(2) Continuous Current	A
(3) Peak Current	A

c. Encoder	
(1) <input type="checkbox"/> Analog <input type="checkbox"/> Digital	
(2) Resolution	μm

f. Motion Direction	
(1) <input type="checkbox"/> Horizontal	
(2) <input type="checkbox"/> Vertical	
(3) <input type="checkbox"/> Tilt _____ Degrees	

d. Working Environment	
(1) <input type="checkbox"/> Room Temperature	
(2) <input type="checkbox"/> Constant Temperature _____ °C	
(3) <input type="checkbox"/> Vacuum _____ Torr	
(4) <input type="checkbox"/> Clean Room _____ Level	

g. Installation Method	
(1) <input type="checkbox"/> Lying Flat	
(2) <input type="checkbox"/> Vertically standing	
(3) <input type="checkbox"/> Wall Mount	

e. Motion Precision	
(1) Positioning Accuracy	μm
(2) Repetitive Accuracy	μm

h. Space Restrictions	
(1) <input type="checkbox"/> None	
(2) <input type="checkbox"/> Yes _____ mm x _____ mm x _____ mm	

